

PARTS & INSTALLATION INSTRUCTIONS





EZ MOUNT PLUS™

SNOW PLOW MOUNTING 17180

2006 & LATER IVECO DAILY 4x4 MODELS



End user must be given this instruction sheet prior to delievery of this Snow Plow.

SAFETY DEFINITIONS



	This is the safety alert symbol. It is used to alert you to potential personal injury hazards. Obey all safety messages that follow this symbol to avoid possible injury or death.
	DANGER Indicates an imminently hazardous situation which, if not avoided, will result in death or serious injury.
	WARNING Indicates a potentially hazardous situation which, if not avoided, could result in death or serious injury.
	CAUTION Indicates an potentially hazardous situation which, if not avoided, may result in minor or moderate injury.
	CAUTION used without the safety alert symbol indicates a potentially hazardous situation which, if not avoided, will result in property damage.

IMPORTANT NOTICE

In conjunction with FMVSS (Federal Motor Vehicle Safety Standards) and OEM (Original Equipment Manufacturer) guidelines, Meyer Products has designed this plow package with the following guidelines:

	Installation of a snowplow may effect your new vehicle warranty. For more information consult your Vehicle Owner's Manual / Vehicle Dealer.
	The vehicle must not be operated when overloaded. In all cases, the loaded vehicle weight, including the entire snowplow system, all aftermarket accessories, driver, passenger, options, nominal fluid levels, and cargo must not exceed the front/rear Gross Axle Weight Rating (GAWR), and total Gross Vehicle Weight Rating (GVWR). These weights ratings are specified on the safety compliance certification label on the driver's side door opening. The use of rear ballast weight may be required to prevent exceeding the front GAWR.



According to the NHTSA (National Highway Traffic Safety Administration) new and untitled vehicles need to be verified by the installer that snowplow and ballast (if needed) do no exceed the front/rear GAWR and total GVWR.

	 Read the Meyer Owner's Manual before operating or servicing a snowplow. FOLLOW THESE INSTRUCTIONS EXPLICITLY.
---	--

GENERAL INFORMATION

	SAFETY PRECAUTIONS should be used when Hydraulic Unit is in OPERATION and plow is in a RAISED position. Lower plow to ground when vehicle is PARKED in case of hydraulic failure.
---	---

Check contents against the parts list to determine all are correct and included, and also to familiarize yourself with them.

	Warranty does not apply to a Meyer or Diamond product which has been negligently or improperly assembled or installed.
	CAUTION: To avoid harm to vehicles electrical system always disconnect battery before beginning installation. DO NOT BURN holes or WELD vehicle frame. This may cause frame failure.

OVERHAUL and SERVICE INFORMATION are covered on separate instructions.

Meyer Products reserves the right, under its continuing product improvement program, to change construction or design details, specifications and prices without notice or without incurring any obligation.



Meyer Products LLC
18513 Euclid Ave. • Cleveland, Ohio 44112-1084
Phone (216) 486-1313
www.meyerproducts.com • email info@meyerproducts.com

PARTS LIST

ITEM	PART NO.	QTY.	DESCRIPTION
	17180		MOUNTING CARTON
1	10225	1	• LH Side Member
2	10224	1	• RH Side Member
3	10226	2	• Brace
4	10229	1	• LH Hanger Weld
5	10228	1	• RH Hanger Weld
	08372	1	• HARDWARE BAG
6	20011	4	•• Bolt H 12-1.50P x 75mm Gr. 8.8
7	20012	4	•• Bolt H 12-1.50P x 60mm Gr. 8.8
8	22741	4	•• Bolt H 12-1.50P x 40mm Gr. 8.8
9	20015	2	•• Bolt H 12-1.50P x 90mm Gr. 8.8
10	20016	2	•• Bolt H 16-1.50P x 110mm Gr. 8.8
11	20330	14	•• Nut 12-1.50P
12	20332	2	•• Nut 16-1.50P
13	20334	14	•• Spring Washer 12mm
14	20335	2	•• Spring Washer 16mm
*	19370	1	Universal Clevis (Part of Plus CLF carton)

Parts indented are included in the carton, bag or assembly under which they are indented.

IMPORTANT

After first use, retighten all mounting bolt connections to specified torque. All mounting bolt connections to be checked periodically for tightness.

Locknuts are furnished **DO NOT** tighten bolts and nuts until installation is complete (unless otherwise specified), then be sure to tighten all attaching parts per specified torque chart.

TORQUE CHART FOOT

Bolt Nut Size	Gr. 2	Gr. 5	Gr. 8
1/4 - 20	4 - 5		
5/16 - 18	9 - 11		
3/8 - 16	17 - 20	26 - 29	
7/16 - 14		42 - 46	60 - 66
1/2 - 13		64 - 72	90 - 100
5/8 - 11		127 - 141	179 - 198

NOTE:

THIS MOUNTING CARTON CAN BE USED WITH THE MDII OR EZ MOUNT PLUS CLF CARTONS.

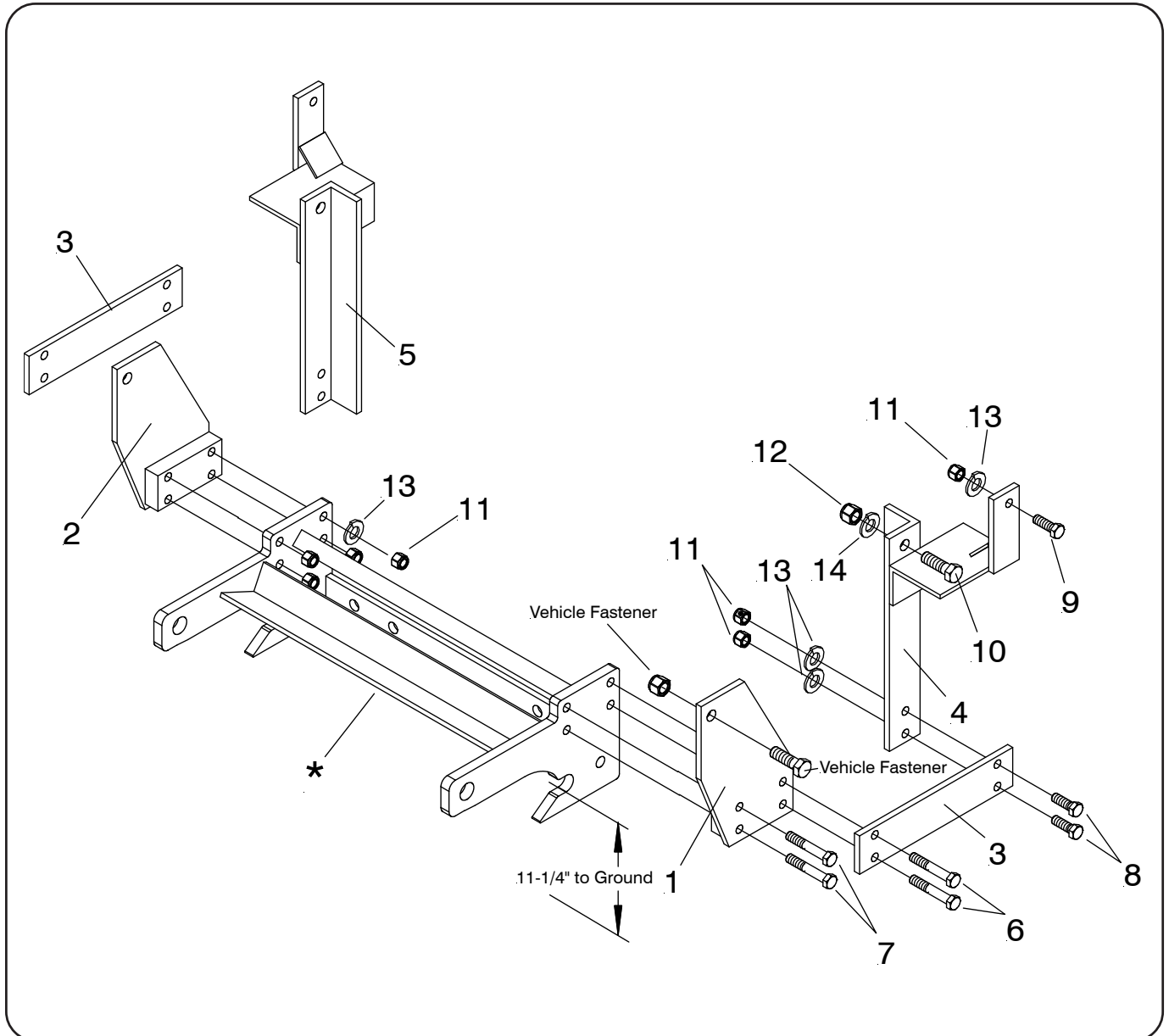

VEHICLE RECOMMENDATIONS

⚠WARNING

- Due to weight restrictions on vehicle's front GAWR, a DP/DPP 7.5 Moldboards only are recommended on vehicles.

⚠WARNING

- A ballast weight may be required to prevent front GAWR overloading. If required, ballast must be securely attached at least 24 inches behind the rear axle.

⚠WARNING

- Front end wheel alignment and headlight aim may require readjustment after installation of equipment, and is the responsibility of the equipment installer. Failure to adjust front wheel alignment may cause premature uneven tire wear. If required, reset to chassis manufacture's specifications found in the Iveco Shop Manual.

Rear ballast is determined by weighing a vehicle's front and rear axles and adding weight behind the rear axle until front axle weight is under or equal to the vehicle specific front GAWR while not exceeding the rear GAWR and GVWR.

Vehicle option packages may vary. If in doubt, it is always a good idea to weigh the vehicle to ensure all weight ratings are not exceeded with plow in the raised position.

INSTALLATION INSTRUCTIONS

- A. Remove sump guard if fitted including rearward vertical posts. Undo forward spring hanger nut and attach LH & RH Side Members (1 & 2) using existing vehicle fastener.
- B. Attach LH & RH Hanger Weld (4 & 5) to sump shield attachment point with Bolts H 16-1.50P x 110mm (10), Spring Washer (14) and Nut 16-1.50P (12). Attach to forward engine mount bracket bolt hole to outside of chassis with Bolts H 12-1.50P x 90mm (9), Spring Washer (13) and Nut 12-1.50P (11).
- C. Attach Brace (3) to LH & RH Side Members (1 & 2) with bolts Bolts H 12-1.50P x 75mm (6), Spring Washer (13) and Nut 12-1.50P (11). Attach LH & RH Hanger Weld (4 & 5) with Bolts H 12-1.50P x 40mm (8), Spring Washer (13) and Nut 12-1.50P (11).
- D. Attach Clevis (*) to LH & RH Side Members (1 & 2) using Bolts H 12-1.50P x 75mm (6), Bolts H 12-1.50P x 60mm (7), Spring Washer (13) and Nut 12-1.50P (11).

Note: before tightening the fasteners, the clevis (*) should be level with the ground and pushed back as far under the vehicle as possible.

- E. Tighten all fasteners to their proper torque. Tighten bolts in the same order they were assembled.
- F. Install remaining snowplow hardware per separate instructions.

Note: when tightening Light Brackets to Lift Frame, you should pull them forward as far as possible, to avoid interference with Iveco hood.

4. Summary

The snowplough retaining device to be fitted onto N1 category vehicles, the specimen presented and tested, and the further types presented as per the documentation, are compliant in terms of design and safety.

The salt spreader retaining device to be fitted onto N1 category vehicles, the specimen presented and tested, and the further types presented as per the documentation, are compliant in terms of design and safety.

The snowplough retaining devices can be installed onto motor vehicles of the following types:

Car type	Watling		Meyer_DrivePro	
	Type Code	Year	Type Code	Year
Volkswagen Amarok (since 2011)	PVW63DT	2011-	17182	2011-
Volkswagen T5 (2007-2010)	0		18515	2007-2010
Toyota Hilux (since 2005)	PTY107DT	2005-	18517	2010-
Toyota Hilux (1997-2005)	PTY109DT	1998-2005	0	
Toyota Landcruiser (2003-2009)	PTY110DT	2003-2009	0	
Mitsubishi L200 (since 2006)	PCM61ADT	2006-	18522	2010-
Mitsubishi L200 (1987-2006)	PCM62DT	1998-2006	0	
Mitsubishi Canter (1998-2004)	0		17131	1998-2004
Mitsubishi Canter (2005-2009)	0		17155	2005-2009
Nissan NP 300 (since 2010)	0		18521	2010-
Nissan NP 300 (1998-2005)	0		0	
Nissan D22 (1998-2005)	PDSN115DT	1998-2005	0	
Nissan Navara D40 (since 2005)	PDSN116DT	2005-	18506	2010-
Nissan Cabstar (since 2005)	0		17132	2005-
Isuzu D-Max/Rodeo Pick-Up (2003-2012)	PIZU19ADT	2003-2012	18516	2003-2012
Isuzu D-Max/Rodeo Pick-Up (since 2012)	PIZU20DT		0	
Ford Ranger (since 2012)	PF103DT	2012-	0	
Ford Ranger (2006-2012)	0		17178	2010-2012
Ford Ranger (since 1998-2006)	PMAZ44DT	1998-2006	18501	1998-2009
Ford Transit Van (since 2006)	PF102DT	2006-	0	
Mazda BT-50 (since 2012)	PF103DT	2012-	0	
Mazda BT-50 (2006-2012)	0		17178	2010-2012
Mazda B2500 (1998-2006)	PMAZ44DT	1998-2006	0	
Mercedes Benz Sprinter 144" with chassis (since 2008)	0		17177	2008-
Mercedes Benz Sprinter Van/ Dodge Sprinter 3500 (since 2006)	PMB49DT	2006-	0	
Jeep Wrangler TJ (1997-2006)	0		18509	1997-2006
Jeep Wrangler JK (since 2007)	PAM38DT	2007-	18507	2007-
Jeep Liberty (since 2003)	0		18503	2003-
Land Rover Defender (1990-1994)	0		0	
Land Rover Defender 90 and 100 (since 1984)	PRO21ADT	1984-	0	
Land Rover Defender (since 1995)	0		18519	1995-
hveco daily 4x4 (2006-2012)	0		17180	2006-2012
hveco daily 2x4 (since 2006)	0		18523	2006-
CITROEN Relay Van & Chassis Cab	PP47DT	2006-2012	0	
FIAT Ducato Van & Chassis Cab	PP47DT	2006-2012	0	
PEUGEOT Boxer Van & Chassis Cab	PP47DT	2006-2012	0	
TOYOTA Landcruiser 1995-2002	PTY111DT	1995-2002	0	

Installation of the snowplough retaining device leaves the width and length of the vehicle unchanged.