

PARTS LIST

ITEM	PART NO.	QTY.	DESCRIPTION
1	07404 07405	1	Snow Plow Light Carton
		1	• Snow Plow Light, Passenger Side (No Hardware)
		1	•• Halogen Bulb HB2
		1	•• Bulb-Amber (3157 NA or 3757 NA)
2	07406	1	• Snow Plow Light, Drivers Side (No Hardware)
		1	•• Halogen Bulb HHB2
		1	•• Bulb-Amber (3157 NA or 3757 NA)
3	07548 07347	1	• Control Module Carton
		2	•• Control Module 12 Volts
4	07609	2	•• Cable (Wires - Black, Green, Yellow, Orange, Red)
5	07118	2	•• Cable (Module "C" to Snow plow light)
6	08701 07119	1	• Hardware Bag (A)
		1	•• Rocker Switch
		1	•• 3 ft. Orange Wire
		1	•• 2 ft. Red Wire with 5 Amp Fuse
		1	•• 3 ft. Black Wire
		1	•• Blue Butt Connector
		5	•• Butt Splice Connectors with Heat Shrink
		3	•• Ring Terminal
		10	•• Nylon Tie Straps
		1	•• Light Switch Mounting Bracket
		2	•• Self Tapping Screws #12-14 x 1/2" Pan Hd.
		4	•• Self Tapping Screw #10 Phillips Pan Hd.
		1	•• Decal, Switch
16	Sold Separately	1	Adapter Kit for Driver & Passenger Side Headlamps (NOT INCLUDED IN LIGHT CARTON)

Parts indented are included in carton, bag or assembly under which they are indented.

Caution: It is important that the Meyer harness, all wires from the Meyer light switch, and all other electrical wires be routed around hot, sharp sheet metal or moving engine parts. Protection must be provided to guard against wire damage at these points. All excess or loose wires must be neatly secured using wire ties. It is highly recommended that all electrical connections are coated with a di-electric compound. See "*" on Figure 1.

Note: Installer is responsible that the Snow Plow Lamps are aimed to comply with Motor Vehicle Standard. Aiming Snow Plow Lamps: Adjust Snow Plow Lamp so that the beams are projected the same distance ahead of vehicle compared to the OEM Headlamps.

When ordering parts, furnish Part No., Name, and Description. Also furnish Vehicle Model and Year. Type of Hydraulic Unit and Moldboard Size.

IMPORTANT:

See Figure 1, Item 3. Meyer Headlamp Control Modules (HCM Meyer part number 07347) must not be mounted on any engine compartment areas that generate heat such as radiators, coolant hoses or metal that is acting as a heat sink. The Module should be located in an area where air flow is available. The HCM module can only be used with standard DOT compliant automotive bulbs. Do not hook up additional lights to the Original Equipment Manufacturers (OEM's) when the HCM is installed. The HCM module is designed to work with standard automotive 12Vdc. electrical systems and has a maximum rating of 15 Amps output. Any use of non standard automotive bulbs or any other wiring, installation or use of the HCM modules that exceeds these specifications, voids and nullifies any implied warranty that may have applied.

Meyer Products reserves the right, under its continuing product improvement program, to change construction or design details, specifications and prices without notice or incurring any obligation.

Meyer Products LLC.
18513 Euclid Ave. • Cleveland, Ohio 44112-1084
Phone 486-1313 (Area Code 216)
www.meyerproducts.com • email info@meyerproducts.com



Meyer Products LLC.
6 Angell Lane • Damariscotta, ME 04543-4507
Phone 563-2227 (Area Code 207)
www.meyerproducts.com • email info@meyerproducts.com

NOTICE: MEYER PRODUCTS ASSUMES NO RESPONSIBILITY FOR INSTALLATIONS NOT MADE IN ACCORDANCE WITH THESE INSTRUCTIONS.

INSTALLATION INSTRUCTIONS

1. First identify vehicle headlamp type per Adapter Cross Reference Chart (Table 2) on the back side of this form. **Confirm the exact adapter kit that is needed for your vehicle.** Installation of an improper adapter kit may result in damage to the headlamp control module, and/or improper operation of lamps. **Use of improper adapter kits will void all warranties applicable to this product.** There will be two adapter harnesses, one for the left headlamp and one for the right headlamp. The adapter harness comes complete with connectors already wired ready to install. The adapters are packaged separately.
2. Mount the lights (1&2) to the light brackets using supplied hardware. Assemble rubber grommets as shown with 1/2" grommet on top. Refer to Figure 6. **Note:** The wire harness exiting from the light housing should be secured against the metal frame of the plow supports. Using tie wraps (supplied), fasten the harness so that it will be located near the grill of the vehicle.
3. Locate the bag marked "Hardware Bag (A)".
 - a) Locate a mounting area for the on/off switch that will not interfere with the operator when entering or exiting the vehicle. Install mounting bracket (13). Using Self Tapping screws (14). Make sure Switch Bracket is in a position so it will not get damaged. Feed the orange (7), red fused wire (8) and black (9) wires through the mounting plate before inserting the switch.
 - b) Route the three (3') foot orange wire (7) through the firewall into the engine compartment. Leave sufficient length of this wire in the engine compartment to connect it later to cable (5) on both the Driver's and Passenger's side.
 - c) The orange wire (7) attaches to the accessory terminal of the switch. The end of the orange wire (7) is provided with a terminal to attach to the light rocker switch (6).

Note the correct position on the switch. Figure 3.

- d) The 12Vdc power must be connected to a switched ignition circuit. Using the red fused (5 amp.) wire (8) supplied, connect it to a fused 12Vdc power source under the dashboard. The fuse panel is a convenient spot to locate this ignition source. Remove the applicable fuse, trim the red fused wire (8) to the correct length, attach the fuse tap to the red fused wire and securely place it in the fuse block with the existing fuse. Attach the other end of the red fused wire (8) to the Light rocker switch (6). **Note the connection that is marked on the switch. Figure 3.**
 - e) The black wire (9) is to be used for the ground connection. Trim the length of wire to suit and using the "forked" spade terminal (12) supplied, connect it to the wire. Fasten it securely to the chassis making sure it is clean of dirt, grease or paint. Attach the other end of the black wire to the accessory switch using the terminal already on the black wire. **Note the connection that is marked on the switch. Figure 3.**
 - f) Once all three wire connections have been made to the light rocker switch (6), carefully feed the wires back through the mounting plate. Firmly push the light switch into place in the switch bracket mounting plate (13).
4. Install the adapter sets (21) for the vehicle's headlamps following the directions listed below. **Note:** The adapters are packaged and sold separately. See paragraph 1.

Figure 6

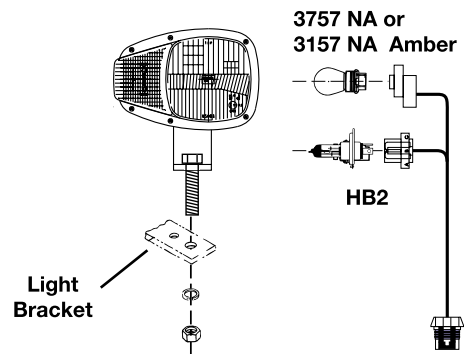
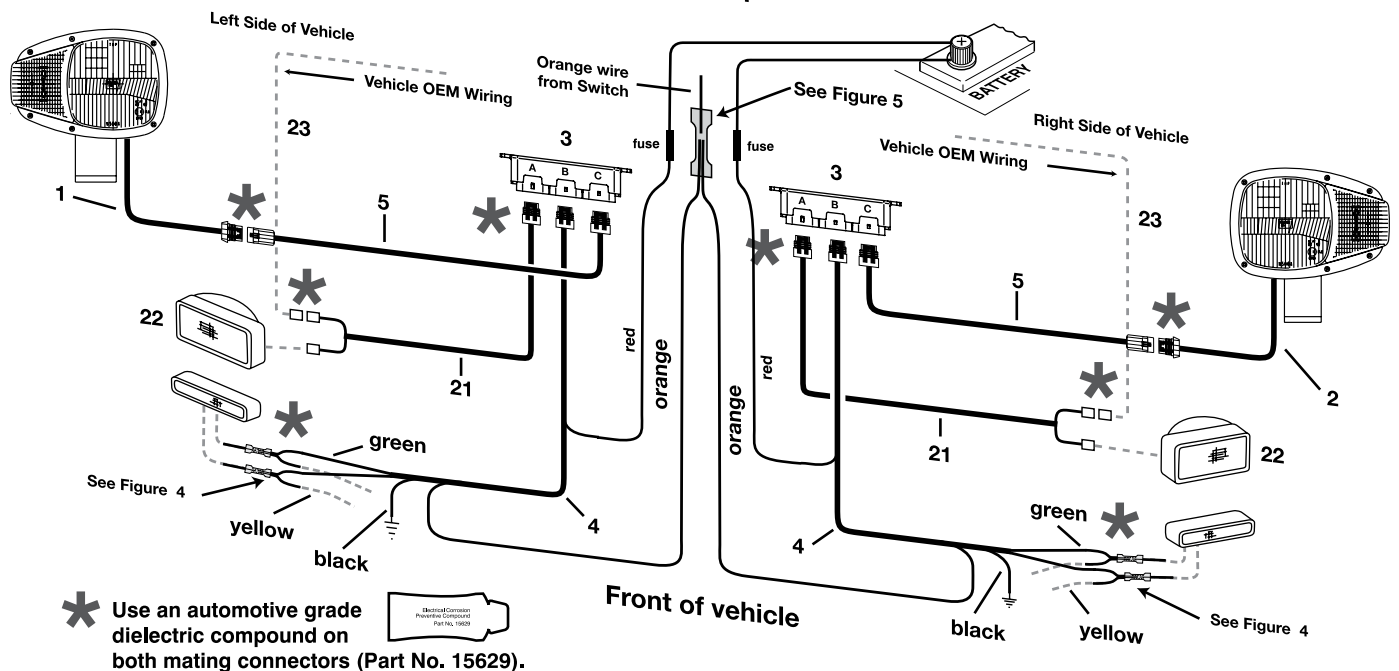
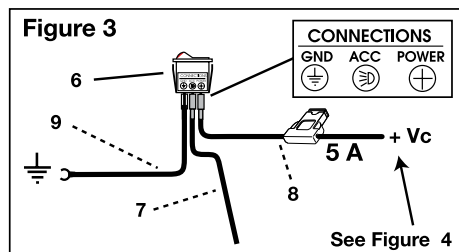
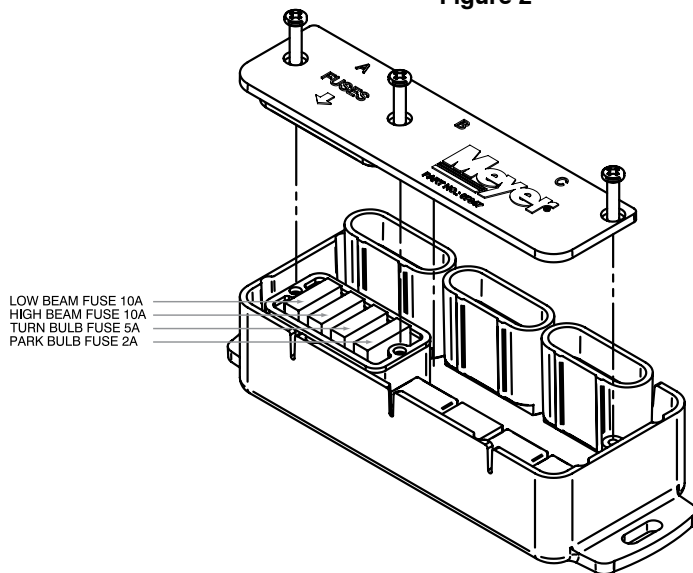

Figure 1



- a) Disconnect the original vehicle's headlamps. Taking one of the adapter harnesses (21), locate the connector for the headlamp (22) and connect. Repeat for the other headlamp using the remaining adapter harness.
 - b) Locate the remaining connector on the adapter harness (21). Connect it to the vehicle's harness (23) at the connector that was disconnected from the headlamp originally. Repeat on the other side of the vehicle.
5. Inside the snow plow lamp carton will be two bags. Inside these bags are all the parts needed to complete the wiring for the vehicle. Please note the parts list for a complete description of what is in each bag.
 6. Install both Headlamp Control Modules (3) in the engine compartment behind each headlamp. Locate the modules as close as possible to the headlamps and try to mount with connectors facing downward. Make sure that they do not interfere with any moving parts and they are surely fastened. Use the nylon tie straps provided to secure the Modules in two places. **See important information on front cover. DO NOT mount module on any engine component that will get HOT.**
 7. Connect Cable (5), to the Control Modules at connector "C" (yellow) and route the cable to the front of the truck grill so that it is accessible from the front and outside of the grill. Secure the end of the cables (5) to the grill with nylon tie straps provided. Connect cables (5) to Snow plow light harness (1&2). These connections should be coated with dielectric compound or tape for added protection. **Refer to Figure 2.**

Figure 2



See Figure 4

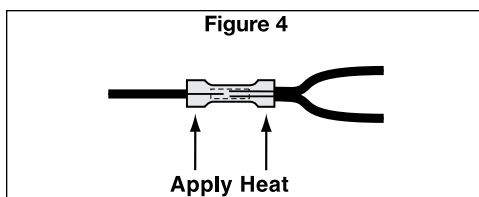
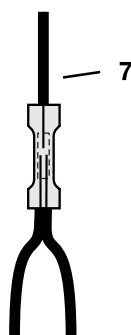

Figure 5



8. Locate vehicle's marker light wires and turn signal wires on the right side of the vehicle. Locate Cable (4) in Module carton parts bag. Using the black tap connectors (11) and the red bullets (11), connect these wires as shown in Figure 1. (No special test light procedure is needed for markers and turn signals.) **Refer to Figure 4 for proper butt splice connector use.**
 - a) Connect the green wire coming from Cable (4) to the "positive" wire of the original equipment turn signal. **Refer to Figure 4 for proper butt splice connector use.**
 - b) Connect the yellow wire from Cable (4) to the "positive" wire of the original equipment parking light wire. **Refer to Figure 4 for proper butt splice connector use.**
 - c) Attach the black ground wire from Cable (4) to a clean ground on the chassis of the vehicle. Crimp the fork spade terminal (12) to the black wire. Use the #10 self tapping screw (15) provided. Make sure this connection is free of grease, paint or dirt.
 - d) Attach the orange wires from Cable (4) to the orange wire (7) at the firewall. Use the supplied butt connector (10) to make the connection. **Refer to Figure 5.**
 - e) **Connect the red wire from cable (4) to positive terminal on battery. An appropriate connector will be required. Not supplied in this kit. Red wire powers snow plow turn signals.**
 - f) Connect the 6 way connector of Cable (4) to the Control Modules (3) at position "B" (green).
9. The final connection is the "A" connection on the Control Modules. Locate the adapter harness with the black six way connector on one side of the vehicle. Connect it to the connector on the Control Module Marked "A" (black). Repeat on the other side of the vehicle. **CAUTION: DO NOT PLUG IN ADAPTER WITH LIGHTS ON.**
10. Verify that installation is correct by turning on the vehicle headlamps, and switching from high to low beam on the vehicle set, then switch over to the plow lamp headlamp set, and check for high and low beam. At any one time, only the plow or vehicle lights should be on, never both sets at once. Verify DRL headlamp function by turning off the vehicle headlamps switch and turning on the ignition key, starting the engine if necessary. You should have DRL function on only one headlamp set (either plow or vehicle, never both). This is true for most installations. Switch over to the other set, and check for proper function.











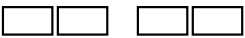

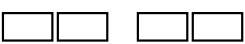



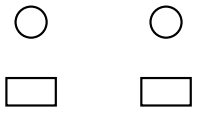

Note: 1999 & Later Chevrolet & GMC vehicles with independent DRL lights (separate from the vehicle headlights), require the installation of a DRL Kit (Light Adapter W/Module). The installation of the DRL Kit will allow both the vehicle and Snow Plow Lights to be on at the same time in the DRL Mode. This is normal operation.

Important: If lights do not function a fuse inside the Module may have failed. To determine the cause of such failure check all OEM, external wire connections, DRL lights, auxiliary lights and fuses.

Remove the Module fuse cover by removing the three screws as shown in Figure 2. Identify the failed fuse and replace with a new fuse of SAME RATING.

Additional lights connected to the Nite Saber light system will void all warranties.

ADAPTER CROSS REFERENCE

ADAPTER KIT NO.	HEADLAMP BULB		SYSTEM TYPE	MANUFACTURER/VEHICLE		CONFIGURATION
	TYPE	TYPE		MODEL YEAR	MODEL YEAR	
07101	2A1 Low 4652 H4656	1A1 High 4651 H4651	4 Lamp Rectangular	Chevy/GMC 1988 thru 2000		
07102	HB5 H9007		Replacement Bulb	Ford F Series 1999 thru 2004 Dodge W Series 2003 thru 2004		
07103	LF Low H4703	UF High H4701	4 Lamp Rectangular			
07104	HB4 Low H9006	HB3 High H9005	Replacement Bulb	Chevy/GMC 1988 thru 2000		
07105	2E1 H4666 H6545 HP6545		2 Lamp Rectangular			
07106	HB1 H9004		Replacement Bulb	Dodge W Series 1999 thru 2002		
07108	HB4 Low H9006	HB3 High H9005	Replacement Bulb	Chevy/GMC 1999 thru 2002 vehicles Avalanche 2002 thru 2003 DRL separate from truck headlamps		
07180	2D1 6014 H6014 6015 H6017 H6024	2B1 6052 H6052 HP6054 H5054 H6054LL	2 Lamp Round 2 Lamp Rectangular	Chevy/GMC 1988 thru 2000 Ford F Series Excursion 2005 and later		
07190	HB5 H9007	HB1 H9004	Replacement Bulb	Dodge Ram Sport 1999 US models only Quad headlamps		
07205	HB4 Low H9006	HB3 High H9005	Replacement Bulb	Nissan Titan 2005 and later		
07213	HB4 Low H9006	HB3 High H9005	Replacement Bulb	Chevy Blazer, S10 and Sonoma 1998 and up		
07221	HB5 H9007	HB1 H9004	Replacement Bulb	Dodge Ram Sport 1999 and up US and Canadian models Quad headlamps		
07333	H11 Low	HB3 High H9005	Replacement Bulb	Chevy X88/GMC Z88 K 1500/2500 Series Tahoe 1/2 ton Suburban 3/4 ton 2007 and up DRL on headlamps		
07334	H13 H9008		Replacement Bulb	GMC Z88 Utility Yukon 1/2 ton Yukon XL 3/4 ton 2007 and up DRL on headlamps		
07343	H13 H9008		Replacement Bulb	GMC Z88 Utility 2007 and later		
07344	H13 H9008		Replacement Bulb	Chevy X88 Utility 2007 and later		
07353	H11 Low	HB3 High H9005	Replacement Bulb	Toyota Tundra 2007 and later		
07400	HB4 Low H9006	HB3 High H9005	Replacement Bulb	Chevy/GMC 2003 thru 2006 vehicles Avalanche 2003 thru 2006 DRL separate from truck headlamps		
07403	TBA		N/A	International Trucks 2000 and up Vehicle must have the manufacturer's snow plow lighting option 08THJ Special light connector is located behind the left headlamp		
07417	H13 H9008		Replacement Bulb	Ford F Series Excursion 2005 and later Dodge 2005 and 2006		
08143	HB4 Low H9006	HB3 High H9005	Replacement Bulb	Chevy Trailblazer 2002 and later		