

19 November, 2021
Version 1.2



Ice **STRIKER™**



OWNER'S MANUAL

600-1000 LITER POLY ELECTRIC TRACTOR SPREADER

This manual replaces all editions with an earlier date.

GENERAL INFORMATION	3
Spreader parts	3
Technical information	4
SAFETY INFORMATION	5
Safety definitions	5
Safety precautions	5
Recommended vehicle requirements	6
Noise	6
Personal safety	6
Emergency stop	6
Warning and caution labels	7
INSTALLATION AND OPERATION	8
Control placement	8
Vehicle side harness cable kit	8
Accessory cables	9
Mounting the top screen	9
Mounting the Tarp cover assembly	10
Spreading pattern	12
Rotate jammed auger manually	12
LOADING	13
Average material weights	13
Filling the integrated pre-wet tank	13
MAINTENANCE	14
Maintaining the spreader	14
Storage	15
OPTIONAL LIQUID SYSTEMS	16
Pre-wet (optional)	16
Spray-bar (optional)	17
Bladder tank (optional)	18
Hose reel (optional)	19
Liquid system clean-out instructions	19
ELECTRICAL SCHEMATIC	20
WARRANTY INFORMATION	21
CERTIFICATE OF CONFORMITY	22

CAUTION

Read this manual before installing or operating the spreader

Spreader parts



Technical information

SPREADER SPECIFICATIONS	600 TR	800 TR	1000 TR
Overall width	1500 mm	1500 mm	1500 mm
Height	1500 mm	1650 mm	1800 mm
Capacity (water level)	550 l	750 l	950 l
Capacity (rounded)	630 l	850 l	1050 l
Weight (empty)	320 kg	360 kg	390 kg
Hopper construction	Poly	Poly	Poly
Spreading width	1-8 m (may vary depending on material)		
Spinner size	390 mm	390 mm	390 mm
Auger diameter	65 mm	65 mm	65 mm
Vibrator	YES	YES	YES
GPS speed control	YES	YES	YES
Vehicle	Tractors/loaders		
Material	Salt, sand, granulat, mixed		

OPTIONAL LIQUID SYSTEM	600 TR	800 TR	1000 TR
Pre-wet, Spray volume	3-12 l/min	3-12 l/min	3-12 l/min
Spraybar, Spray volume	5-25 l/min	5-25 l/min	5-25 l/min
Pre-wet, Spraying width	1-8 m (together with spreading material)		
Spraybar, Spraying width	2-5 m	2-5 m	2-5 m
Pre-wet, liquid tank capacity	330 l	330 l	330 l
Spraybar, liquid tank capacity	330/900 l *	330/900 l *	330/900 l *
Spraying material	Anti- and de-icing liquids, water, liquid fertilizers **		

Safety definitions

**WARNING**

Implies a potentially hazardous situation that, if not avoided, could result in death or serious personal injury.

**NOTE**

Implies a situation or action that can lead to damage to your spreader and vehicle or other property. Other useful information can also be described.

**CAUTION**

Implies a potentially hazardous situation that, if not avoided, may result in minor or moderate injury. It may also be used to alert against unsafe practices.

Safety precautions

Incorrect installation and operation can lead to serious personal injury and/or damage your equipment and property. Note and ensure that you understand this manual and all the labels before installing, operating or making adjustments to the spreader.

**WARNING**

Observe these safety precautions before, during and after operating the spreader. You can prevent injury to persons and damage to the spreader by following these precautions.

1. Read this manual before operating the spreader.
2. Before operating, make sure all the equipment is securely mounted into place.
3. Check that there are no persons within the spreader spray area when starting and operating this spreader.
4. Do not exceed your vehicle total weight beyond payload limits.
5. Always turn off the spreader before cleaning, lubricating or unclogging material jams.
6. Never climb or ride on or in the spreader.
7. Ensure that you have fastened the spreader to the vehicle according to descriptions in this manual.
8. A spreader in need of repairs or maintenance should not be operated.
9. Before removing or replacing any electrical components, always disconnect the battery.
10. Do not keep gasoline or other flammable liquids on the truck bed while spreader is mounted on the truck bed.

WARNING
Always keep bystanders a minimum of 10 meters away when operating the spreader.

CAUTION
Empty and clean the hopper after each use. Unused spreading material left in hopper could freeze or solidify, causing the spreader to not work properly.

WARNING
Wait for auger and spinner to stop and lock out power before servicing the spreader.

NOTE
Use a good quality multi-purpose grease to lubricate grease fittings after each use.

Recommended vehicle requirements

This spreader is suitable for tractors and loaders with a minimum lift capacity of 2000 kg.

Noise

The noise caused by the running spreader does not exceed 70 dB

Personal safety

- To prevent accidents, secure long hair and do not wear jewelry or necktie, only wear tight-fitting clothes while working on your spreader or vehicle.
- Protect your eyes with safety goggles to avoid damage from battery acid, gasoline, dirt and dust.
- Always handle the solid and liquid materials carefully. Wear safety goggles, mouth mask, gloves and protecting clothes to protect yourself from spattering material.

Emergency stop

The spreader has an emergency stop button located at the right side of the chute. All spreader functions will immediately stop by pushing this button.



Warning and caution labels

Please become familiar with warning and caution labels on the spreader.

Warning - Handling of abrasive and chemical material can cause injury

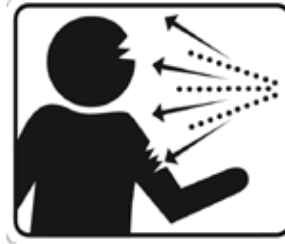

- Visible when removing the spinner assembly

Warning - Rotating auger! Keep hands clear. Wrench might slip when working with auger

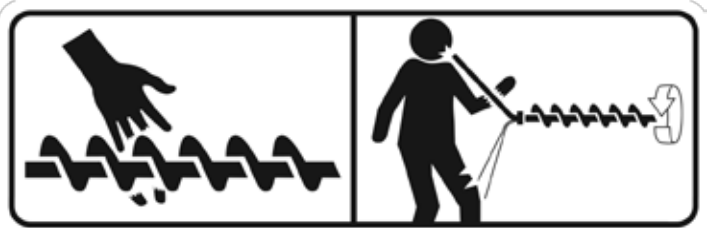

- Located on the chute

Warning - Keep away from spinner and spreader in motion. Stay clear of turning spinner. Moving parts can crush and cut



Control placement

The controller should be mounted in a place where it can easily be reached and doesn't interfere with the access to vehicle controls or other equipment. Make sure that the spreader control panel doesn't block any vehicle airbag areas. Protect the controller from water, dirt and dust.



Vehicle side harness cable kit



Vehicle side harness cable kit

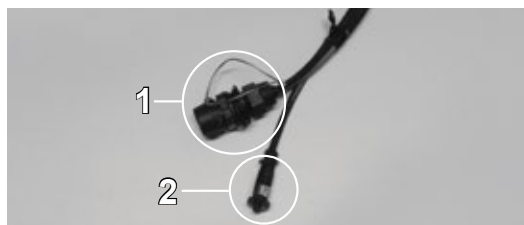

1. Power connector to spreader
2. Data connector to spreader

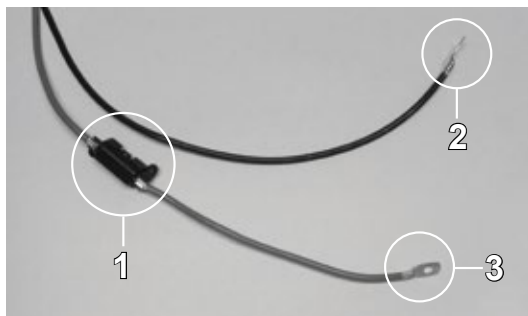

To vehicle battery

1. 80A fuse
2. Black (-)
3. Red (+)



In-cabin connector

Accessory cables

Red	=	Emergency stop (standard)
Black	=	Water pump
Yellow	=	Beacon light
Blue	=	Camera power feed
White	=	LED worklight



Mounting the top screen

Place the screen so that it fits the hopper opening.

Fasten the brackets on both sides of the screen, the flat bracket should be in the middle.

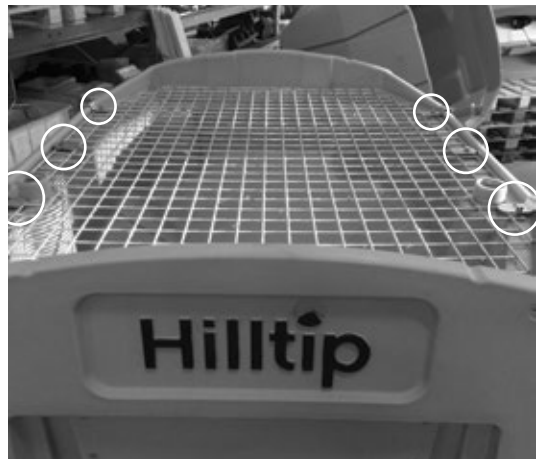

Mounting the Tarp cover assembly

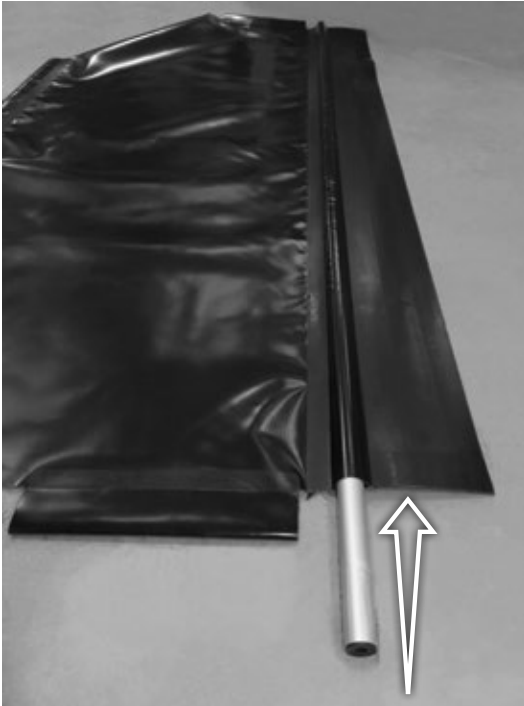

1 Insert one of the longer pipes into the opening in the cover (pre-mounted)



2 Insert brackets in both sides.



3 Connect pipe and brackets with bolts in both ends.

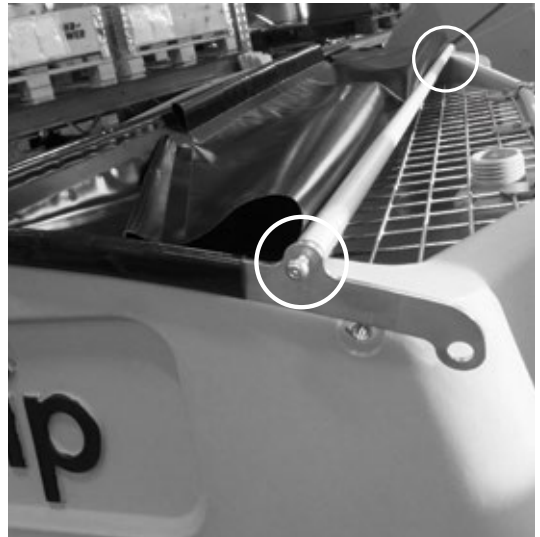

4 Place the second long pipe under the cover and connect to the brackets using bolts

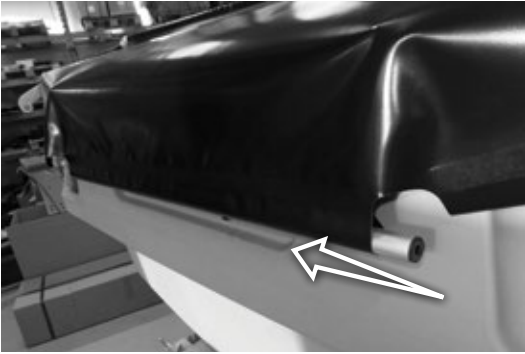

5 Insert the short pipe into the cover, parallel to the other pipes.



6 Insert rubber wires into the two remaining openings in the cover.



7 Place washer and bush around the bracket, as shown in the picture.



8 Connect washer, bracket, bush and rubber wire with bolt.



9 Fasten the rubber wire and the shorter pipe with bolt.

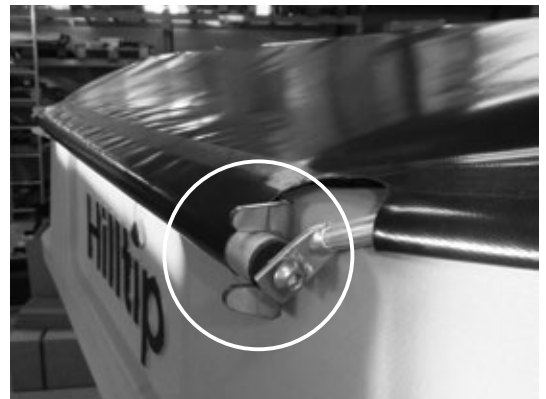

10 Fit pipe to the brackets attaching the screen, and make sure the whole tarp cover assembly is properly fastened

Spreading pattern

Rotate the spinner plate to position the material drop point and change spreading pattern.

⊗ = material drop point

Drop point in center

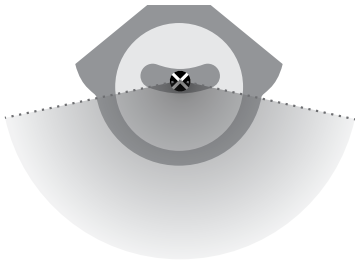

Spinner plate rotated cw

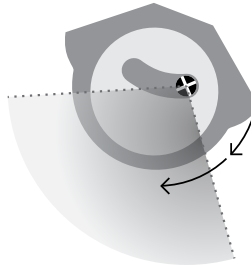

Spinner plate rotated ccw

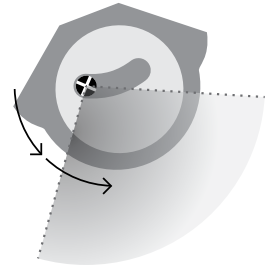

Rotate jammed auger manually

If the error code “Auger jammed” appears, the auger can be rotated manually to release any solidified material or rocks. Always turn off the spreader before servicing it. Use a 17 mm socket wrench or similar tool to turn the auger screw.



Rotate auger manually by turning it clockwise

Average material weights

Material	Weight (kg/m ³)
Fine salt - dry	1201
Coarse salt - dry	721
Coarse sand - dry	1602
Coarse sand - wet	1922

Please see your local dealer for proper vehicle applications.



WARNING

Do not overload your vehicle beyond GVWR or GAWR, overloading could result in accident or damage.



CAUTION

These material weights are only guidelines, for more precise data, read and adhere to the manufacturer's ice-control material package labeling, including Material Safety Data sheet requirements.

Filling the integrated pre-wet tank



NOTE

Only use water or de-icing liquids for the pre-wetting system

The hopper body has an integrated tank that should be used only if you had the optional pre-wetting system included to your spreader package. Only use liquids recommended in this manual.

The opening to the integrated pre-wetting tank is covered by a lid, and located on the side, inside the hopper body



Maintaining the spreader



WARNING

Power should always be shut off before and during service or maintenance of the spreader.



WARNING

Never remove spreader with material in hopper



NOTE

You must follow all the steps in these maintenance checklists for warranty to be valid.



CAUTION

- Do not operate a damaged spreader or a spreader in need of maintenance
- Spreader should be emptied and cleaned after each use. Left over material could freeze or solidify in the hopper causing the spreader to not work properly.



NOTE

Always close hopper lids to avoid moisture build-up. Do not let spreader sit idle with material in the hopper for a longer time. This could lead to compact material, reduced or blocked material flow and cause damage to the hopper.

Periodical maintenance checklist (check weekly in high-season)

Clean the hopper carefully inside and out with water. Avoid spraying water into bearings, motor and electrical connections.

Check that all screws and fasteners are tight enough. If you notice any missing or damaged fasteners or other parts, replace immediately.

Check that all installations and parts are still securely fastened to the spreader assembly.

Apply dielectric grease on all electrical connections.

Lubricate grease fittings with a good quality multipurpose grease.

Yearly maintenance checklist (e.g. before or after putting your spreader away for storage)

Clean the hopper carefully inside and out with water, before putting it in storage. Avoid spraying water into bearings, motor and electrical connections.

Clean and apply dielectric grease on all electrical plugs and connectors. Clean and install all dust caps before placing your spreader in storage

Lubricate grease fittings with a good quality multipurpose grease.

Check condition of bearings, replace if needed.

Cover the spreader with a tarp during storage, to protect it from sun fading and other weather conditions and circumstances.

IMPORTANT:

It is strongly recommended and of great importance that you regularly apply dielectric grease on all electrical connections and protect them with caps when not in use to prevent corrosion.



Always keep caps on when the cables are not connected or in use.



To prevent corrosion, use dielectric grease on electrical connectors before connecting them.



While cables are connected, also connect matching caps to protect them from dirt and dust.

Storage

Apply to these recommendations before placing your spreader in off-season storage to maintain it in a good condition.

- Cover your spreader using a tarp during storage periods
- Apply a protective compound such as dielectric grease on all electrical connectors and use caps for protection before storage.
- Disconnect and remove the control unit from your vehicle. Store it in a dry and cool place, and protect it from heat and moisture.
- Empty the hopper, remove all kinds of debris and clean the hopper from dirt before storage.
- Protect the hopper from excessive heat during storage periods.

Caution!

The liquid tank should always be emptied after each use (turn the red handle). Also empty the filter. If liquids are left in the tank for an extended period of time, it may freeze and cause damage to your spreader.

Also make sure to clean the filter regularly.



Pre-wet (optional)

1. Start with selecting PRE-WET as spreading mode in the controller.
Go to: Main menu > Settings > Wetting > select Pre-wet
2. You will find a handle on the right side of the chute. Point the handle towards PRE-WET

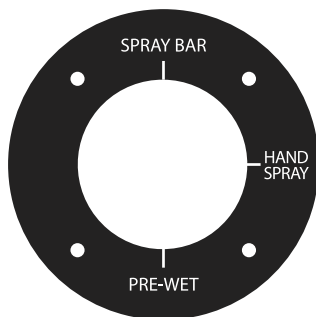

Spray-bar (optional)

1. Start with selecting Spray-bar as spreading mode in the controller.
Go to: Main menu > Settings > Wetting > select Spray-bar

2. You will find a handle on the right side of the chute. Point the handle towards SPRAY BAR

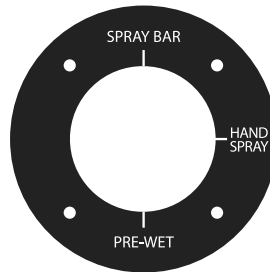

3. Attach spray-bar to the chute:

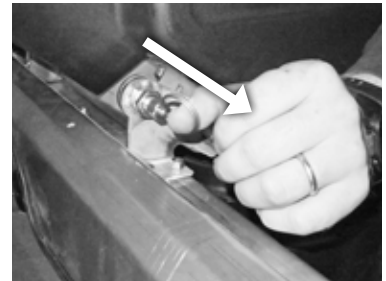
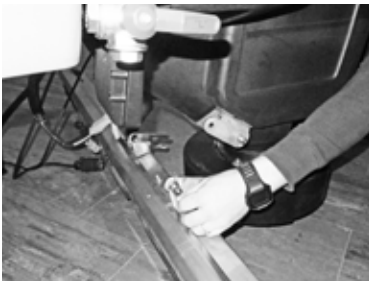

4. Attach hose to the spray bar and fasten the cotter pins on both sides



Quick-disconnect point

5. Turn the red cap to turn on the liquid flow to the side nozzles (will increase the spray width with 1-1,5 m on each side)



6. Turn nozzle to change nozzle type:



Bladder tank (optional)

1. You will find a handle on the left side of the chute. Point the handle towards BLADDER TANK

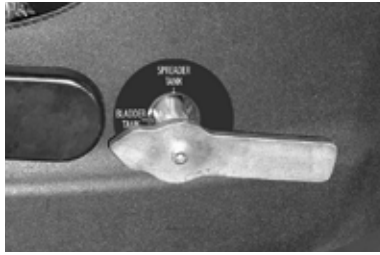

2. Remove the plug from the bottom of the spreader

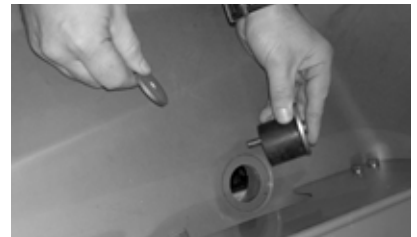

3. Place the bottom support plate and bladder tank. Pull the hose through the hole of the plate and the hopper.



4. Place and fasten the metal bars on top of the hopper, strap the bladder tank to the bar.

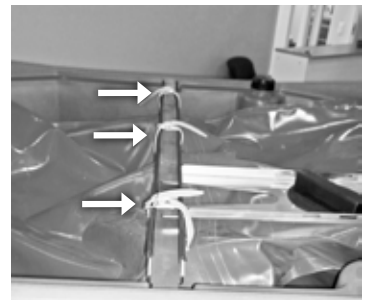
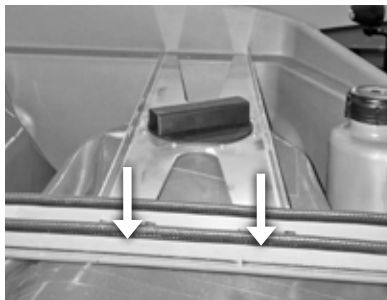

5. Fasten the hose from the bladder tank to the spreader liquid system (under the hopper)

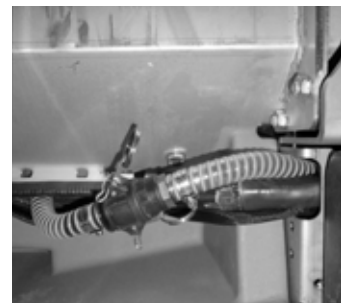

Hose reel (optional)

1. Start with selecting Hand spray as spreading mode in the controller.
Go to: Main menu > Settings > Wetting > select Hand spray

2. You will find a handle on the right side of the chute. Point the handle towards HAND SPRAY

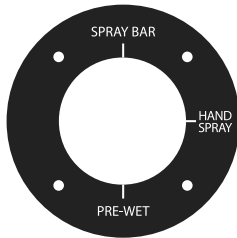

IMPORTANT!

Liquid system clean-out instructions

1. Disconnect spraybar hose at rear of vehicle at Quick-disconnect point. (see page 17)
2. Turn on pump until the hopper tank is empty (alternatively pump the salt liquid back into your storage tank). Once empty, turn off the pump.
3. Disassemble the filter.
4. Connect and press the clean-out hose installed with cone into pump inlet inside filter hosing.
5. Add water and RV antifreeze into a barrel, where you put the other end of the clean-out hose.
6. Turn on pump.
7. Reinstall quick-disconnect hose to hosereel/spraybar.
8. Run pump until it is running clear out of each nozzle.

Attention! Ignoring these important steps may cause damage to the pump and the entire liquid system. **If damage is caused by avoiding these steps, the warranty will no longer be valid.**

Electrical schematics - IceStriker 600-1000 TR

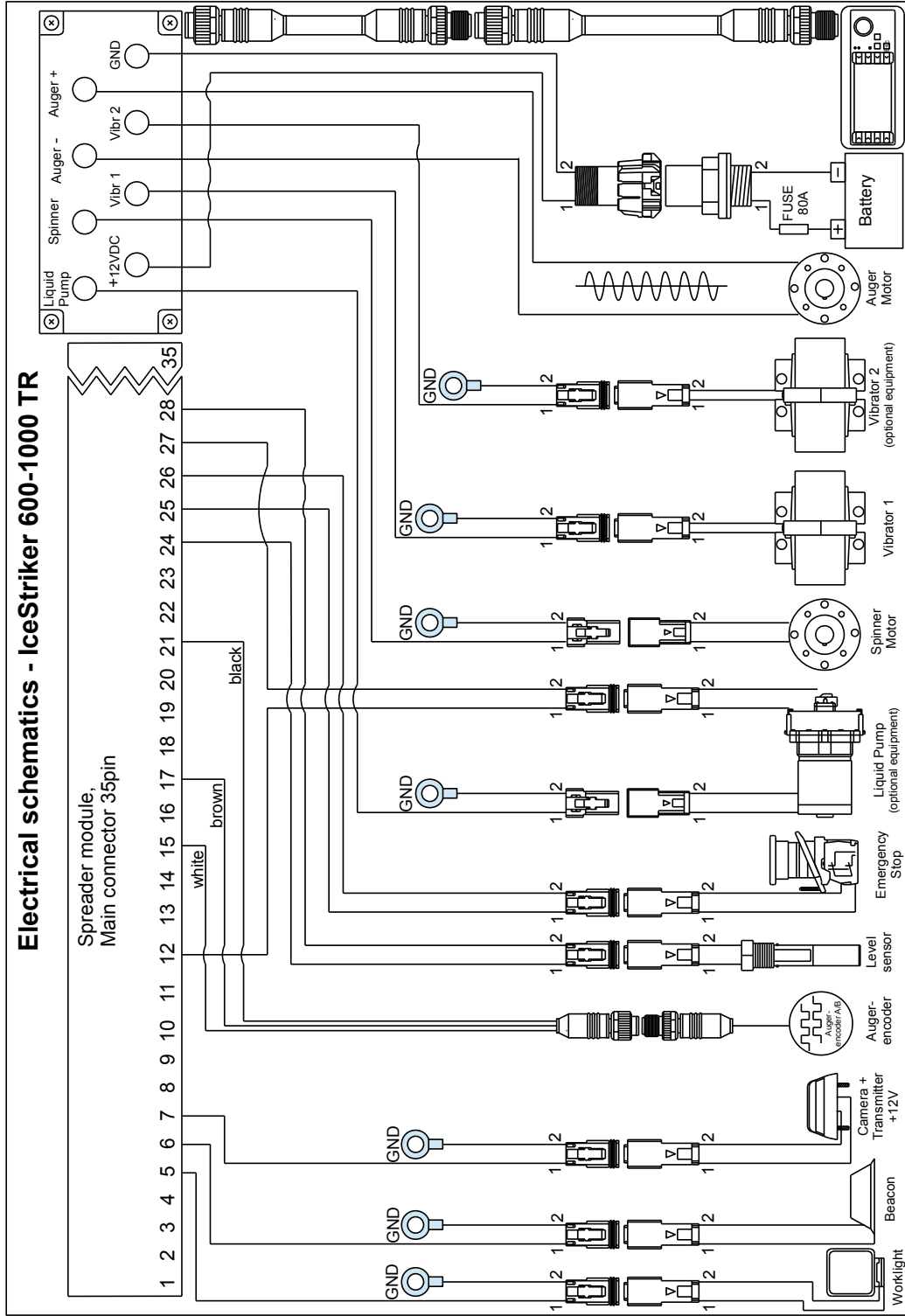

WARRANTY INFORMATION

This warranty replaces all previous warranties

Warranty

This Limited Warranty applies to the IceStriker™ spreader, its spare parts and additional equipment (from now on referred to as the "product"), purchased from Hilltip or an authorized dealer.

What does this limited warranty cover?

This Limited Warranty covers any defects in material or workmanship under normal use during the Warranty Period.

During the Warranty Period Hilltip or an authorized dealer will repair or replace, at no charge, products or parts of a product that proves defective because of improper material or workmanship under normal use and maintenance.

What will we do to correct problems?

Hilltip or an authorized dealer will repair or replace the product or part at no charge using either new or refurbished replacement parts.

How long does the coverage last?

The Warranty Period for products purchased from Hilltip, or an authorized dealer is two (2) years from the date of purchase. The warranty period for a replacement part is one (1) year from the date of replacement or repair.

What does this limited warranty not cover?

Parts must be properly installed and used under normal conditions for the warranty to be valid. Modification of the product, and/or the vehicle, is entirely at the purchaser's risk. This warranty does not include compensation for the drive to the service spot. Any damage in transit will be the responsibility of the carrier or at the risk of the purchaser. Hilltip will not provide replacement equipment or cover rental costs while your equipment is out of service.

This Limited Warranty does not cover any problem that is caused by:

- Misuse, neglect, accident, improper installation, maintenance or storage, or repair or alternation by anyone except Hilltip or an authorized dealer.

What do you have to do?

To obtain warranty service, you must first contact us or your authorized dealers. The purchaser must notify Hilltip or an authorized dealer within ten (10) days after any defect in the product becomes known during the warranty period.



DECLARATION OF CONFORMITY

Manufacturer's & Assambler's Name: **Oy Hilltip Ab**

Manufacturer's & Assambler's Address: **Pukisaarentie 6, FIN-68600 Pietarsaari, Finland**

Equipment Description: Salt, Sand and Fertilizing Spreader and Spray applications, 600-1000 liter

Equipment Model Designation: Hilltip IceStriker 600 TR
Hilltip IceStriker 800 TR
Hilltip IceStriker 1000 TR

Equipment applications: Tractors and loaders

The equipments specified above are manufactured, where applicable, in conformity with provisions of the normative document according to the following directives and standards, in addition to relevant Road Traffic Regulations in European countries:

- 2006/42/EC
- EN 15597-1

I, the undersigned, hereby declare that the equipments specified above, that have been assembled by Oy Hilltip Ab, conforms to the above directives and standards

Pietarsaari 10th August, 2020

Signature:

Printed Name: Tom Mäenpää

Title: CEO

Installer's Name:

Installer's Address:

Type:

Serial number:

Year of installation:

I, the undersigned, hereby declare that the equipment installation to the vehicle specified above conforms to the directive 2006/42/EC and relevant Road Traffic Regulations.

DATE:

Signature:

Printed:

Title:



Oy HillTip Ab

Pukkisaarentie 6
FIN-68600 Pietarsaari
Finland

Phone: +358 50 5983 026

Phone: +358 50 3659 415

www.hilltip.com

info@hilltip.com

Construction, specifications and other details are subject to change without notice.